

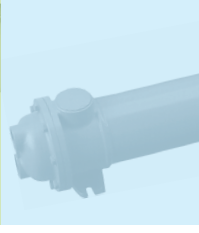

**KONUK ISI**<sup>®</sup>  
MAK. SAN. VE TİC. LTD. ŞTİ.

[konukisi.com](http://konukisi.com)

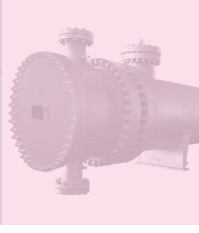
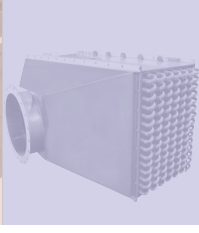
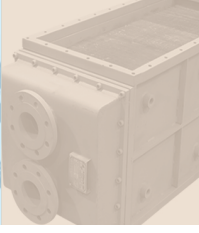
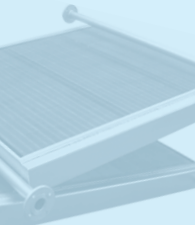
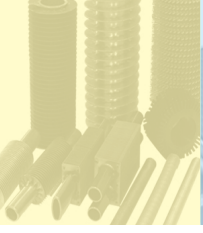

## ISITMA APAREYLERİ HEATING EQUIPMENTS





KONUK ISI, 1987 yılından beri ısıtma ve soğutma sektörüne yönelik ürün çeşitleri ile "ısıнын değiştirilmesi gereken her yerde biz varız" ilkesi ile yoluna devam etmektedir. Müşteri memnuniyetini her zaman ön planda tutan KONUK ISI, yeni nesil ısıtma apareylerine kattığı estetik görünüm ve ürün kalitesi ile bunu pekiştirmeyi hedeflemiştir.

*Since 1987, having its own product range in heating and cooling industry, KONUK ISI continues on its way by stating its principles as "We are in everywhere where heat is to be exchanged". KONUK ISI always keeping customers' satisfaction ahead, has succeeded to establish this habit by giving an esthetic appearance to its new generation Heating Equipments and by product quality.*

## KULLANIM ALANLARI / AREAS OF USE



Apareyler, diğer ısıtma yöntemlerinin yetersiz kalacağı toplantı salonu, süpermarket, fabrika, depo, spor salonu gibi geniş alanlarda, ekonomik ve pratik bir çözüm olarak rahatlıkla kullanılabilir.

Tesislerde mevcut olabilecek, kızgın yağ, buhar, sıcak su veya kızgın su gibi farklı sistemlere göre tasarlanan batarya seçenekleri ile üretilen standart ürün çeşitlerimiz, her türlü ihtiyaca cevap verebilecek çeşitliliğe sahiptir.

Toplantı salonları gibi sessizlik unsurunun önemli olduğu mekânlarda tavan tipi apareylerin kullanılması tavsiye edilir. Fabrika alanları gibi tavan yüksekliğinin ve ısıtılacak hacmin fazla olduğu mekânlarda ise, daha uzun üfleme mesafesine sahip olan duvar tipi apareylerin kullanılması tavsiye edilir.

*Heating Equipments can be used as an economical and practical choice in where other heating methods will be insufficient in large places like auditoriums, supermarkets, factories, warehouses, fitness centers.*

*Our standart products which are manufactured with coil choices for different systems as those utilizing hot oil, steam, heated water or hot water, have a range that will supply all the requirements.*

*It is recommended to use ceiling type Heating Equipments in places like auditoriums in where silence has an importance. In places where ceiling height and volume to be heated is large like factory buildings, it is adviced to use Heating Equipments which have longer blowing distances.*

## TASARIM ESASLARI / DESIGN PRINCIPLES

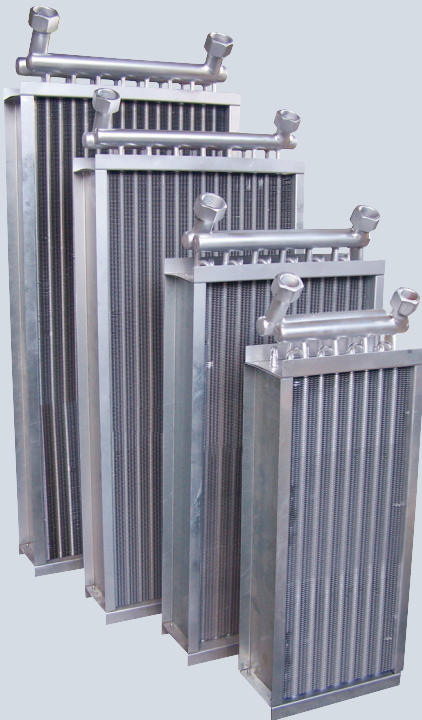

## BATARYA / COIL

Bataryaların boru ve fin malzemesi, sistemin çalışacağı akışkan cinsine ve çalışma basıncına uygun olarak seçilir. Ürün kapasitesini sağlayabilecek ısı transfer yüzey alanı, hava debisi ve basınç kaybı göz önünde bulundurularak, özel bir yazılım programı kullanılarak hesaplanır. Tüm batarya tipleri kapasiteyi sağlayacak tasarım esaslarına göre, firmamız bünyesinde üretilir.

### Sistem Akışkanı

Kızgın Yağ  
Buhar  
Sıcak Su  
Kızgın Su

### Batarya Tipi

Çelik Boru-Çelik Fin  
Çelik Boru-Çelik Fin  
Bakır Boru-Alüminyum Fin  
Bakır Boru-Alüminyum Fin (Basınç maksimum 3 ATU)

*Tube and fin materials of coils are selected properly according to the fluid type and operating pressure that the system will work. Heat transfer area that meets product capacity is calculated by a special software considering air flow rates and pressure losses. All coil types are manufactured in our site according to the design principles providing the necessary capacities.*

### Working Fluid

Hot Oil  
Steam  
Heated Water  
Hot Water

### Type of Coils

Steel Tube-Steel Fin  
Steel Tube-Steel Fin  
Copper Tube-Aluminium Fin  
Copper Tube-Aluminium Fin (Pressure maximum 3 ATU)



### PANJUR-ÇERÇEVE / SHUTTER-FRAME

Havanın çıkış yönünü değiştirebilecek şekilde tasarlanan panjur-çerçeve sistemi ile, üfleme mesafesi maksimuma çıkartılmıştır. Panjur-çerçeve sisteminde, eloksal kaplı alüminyum kullanılarak, ürüne uzun süreli bir parlaklık kazandırılmıştır.

*Blowing distance is maximized by designing the shutter-frame system in such that they can change the air exit direction. By using eloxal coated Aluminum the shutter-frame system gained long lasting brightness.*

### FAN-MOTOR / FAN-MOTOR

Kaliteye önem verilen yeni nesil apareylerde ses seviyesinin ve titreşimin en düşük seviyede tutacak şekilde seçilmiştir.

Tavan tipi apareylerde aksiyel fan-motor sistemi, duvar tipi apareylerde kendinden rotorlu radyal fan-motor sistemi kullanılmıştır.

*In order to decrease the noise level and vibration in the new generation Heating Equipments, where quality is an important issue, the fan systems are preferred. In ceiling type Heating Equipments axial-fan motor system, in wall type Heating Equipments internally rotoed radial-fan motor system is used.*

### KABİN / CABIN

Kabin boyutları, kullanılan fan çapına göre, en etkin hava akışını sağlayabilecek biçimde tasarlanmıştır.

Estetiğe önem verilen yeni nesil duvar tipi apareylerde, kendinden rotorlu radyal fan-motor sistemi tercih edilerek motor kabin içine alınmıştır.

Eloksal kaplı alüminyumla uyum sağlaması amacıyla, kabinlerde standart olarak Hammerton 701 Gümüş Gri boya tercih edilmiştir.

*Depending on the fan diameter the cabin dimensions are designed to give the most effective air flow. In new generation wall type Heating Equipments where esthetic considerations are important, the internally rotoed radial-fan motor system is preferred and the motor is placed inside the cabin.*

*In cabins to comply with eloxal coated Aluminum, Silver Grey Hammerton 701 is preferred as a standart dye.*

### MONTAJ ve BAKIM / MOUNTING and MAINTENANCE

Apareyin giriş-çıkışları, montaj kolaylığı sağlayacak şekilde tasarlanmıştır. Montaj işlemleri, özel tesisat malzemelerine ve ekipmana ihtiyaç duyulmadan, ehliyetli bir kalorifer tesisatçısı tarafından rahatlıkla gerçekleştirilebilir.

*The inlets and outlets of the Heating Equipments are designed so that they require simple mounting. Mounting operations can achieved easily by a proficient radiator installer without necessitating any special installation materials and equipments.*

### Ürün Kodlaması / Type Indication

Örnek / Example: KDA 25 KY

Konuk Isı-Isıtma Apareyi Tipi / Konuk Isı Heating Equipment Type

KDA: Radyal Fanlı Duvar Tipi Aparey / Wall Type Heating Equipment with Radial Fan KTA: Aksiyel Fanlı Tavan Tipi Aparey / Ceiling Type Heating Equipment with Axial Fan KDA

Kapasite / Capacity

6-8-10-12-15-20-25-30-35-40-50 25 : 25.000 Kcal/saat / 25.000 Kcal/hour

25

Akışkan / Fluid

KY : Kızgın Yağ / Hot Oil BH : Buhar / Steam SS : Sıcak Su / Heated Water KS : Kızgın Su / Hot Water

KY

\* Katalog bilgilerinde haber verilmeksizin değişiklik yapma hakkı tarafımızca saklı tutulur.  
\* All rights of changing any technical information are reserved without notice.

R: 02 NİSAN 2013  
APRIL 2013

Sıcak Su ve Kızgın Su İçin Performans Değerleri / Performance Values For Heated Water and Hot Water

SU SICAKLIĞI WATER TEMPERATURE	HAVA GİRİŞ SICAKLIĞI AIR INPUT TEMPERATURE		5°C		10°C		15°C		18°C	
	Ürün Tipi	Üfleme Debisi m <sup>3</sup> / saat	Kapasite Kcal / saat	Hava Çıkış Sic. °C	Kapasite Kcal / saat	Hava Çıkış Sic. °C	Kapasite Kcal / saat	Hava Çıkış Sic. °C	Kapasite Kcal / saat	Hava Çıkış Sic. °C
	Product Type	Air Flow m <sup>3</sup> / hour	Capacity Kcal / hour	Air Output Temp. °C	Capacity Kcal / hour	Air Output Temp. °C	Capacity Kcal / hour	Air Output Temp. °C	Capacity Kcal / hour	Air Output Temp. °C
90-70 SICAK SU İÇİN FOR 90-70 HEATED WATER	KDA 6	1150	7.700	26	7.100	30	6.510	34	6.150	36
	KDA 8	1250	10.200	31	9.400	34	8.610	38	8.130	40
	KDA 10	1150	12.700	40	11.740	43	10.780	46	10.210	48
	KDA 12	1100	15.000	49	13.870	51	12.750	54	12.090	55
	KDA 15	2200	19.350	33	17.910	36	16.470	40	15.620	42
	KDA 20	2100	25.390	44	23.470	47	21.580	49	20.450	51
	KDA 25	2700	31.370	42	29.030	45	26.710	48	25.340	49
	KDA 30	2770	37.180	48	34.400	51	31.650	53	30.020	54
	KDA 35	2700	44.110	58	40.820	60	37.570	61	35.650	62
	KDA 40	4100	49.750	44	46.070	47	42.430	49	40.270	51
KDA 50	4050	63.140	55	58.460	57	53.840	59	51.110	60	
110-80 KIZGIN SU İÇİN FOR 110-80 HOT WATER	KDA 6	1150	9.080	30	8.470	34	7.870	38	7.510	40
	KDA 8	1250	12.030	36	11.230	39	10.420	43	9.940	45
	KDA 10	1150	15.100	47	14.120	50	13.150	53	12.570	55
	KDA 12	1100	17.920	57	16.770	60	15.640	62	14.970	64
	KDA 15	2200	23.000	39	21.540	42	20.090	45	19.230	47
	KDA 20	2100	30.260	51	28.310	54	26.390	57	25.250	58
	KDA 25	2700	37.420	50	35.040	52	32.690	55	31.290	57
	KDA 30	2770	44.440	57	41.610	59	38.820	62	37.150	63
	KDA 35	2700	52.980	68	49.610	70	46.300	72	44.330	73
	KDA 40	4100	59.470	52	55.730	55	52.030	57	49.830	59
KDA 50	4050	75.820	65	71.040	68	66.330	70	63.530	71	
130-90 KIZGIN SU İÇİN FOR 130-90 HOT WATER	KDA 6	1150	10.410	34	9.790	38	9.190	41	8.820	44
	KDA 8	1250	13.800	40	12.990	44	12.180	47	11.690	49
	KDA 10	1150	17.450	54	16.460	57	15.480	60	14.890	62
	KDA 12	1100	20.800	66	19.630	69	18.480	71	17.790	73
	KDA 15	2200	26.580	44	25.110	47	23.650	51	22.770	53
	KDA 20	2100	35.040	59	33.070	62	31.120	64	29.960	66
	KDA 25	2700	43.380	57	40.970	60	38.590	63	37.170	64
	KDA 30	2770	51.600	65	48.720	68	45.880	70	44.190	72
	KDA 35	2700	61.750	79	58.310	81	54.920	83	52.910	84
	KDA 40	4100	69.050	59	65.260	62	61.510	65	59.270	67
KDA 50	4050	88.370	75	83.500	78	78.690	80	75.840	81	

Teknik Özellikler / Technical Characteristics

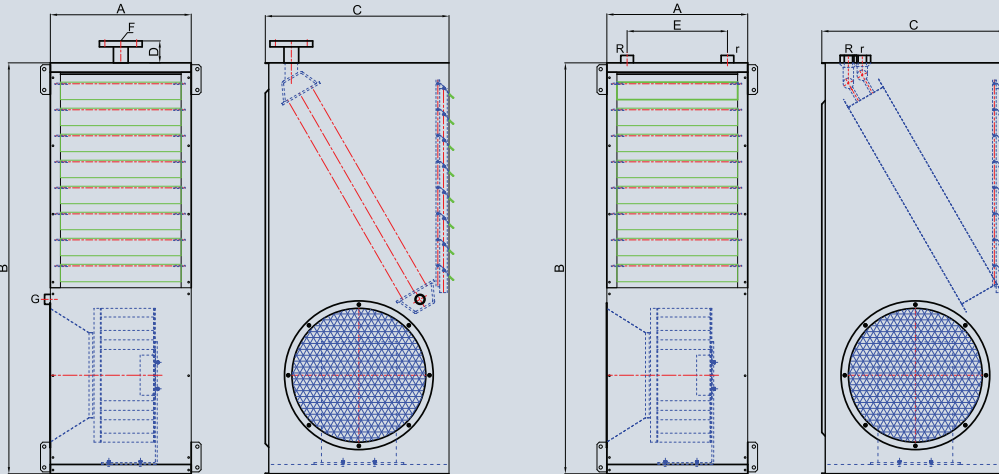

Buhar Tipi / Steam Type

Sıcak Su Tipi / Heated Water Type

ÜRÜN TİPİ PRODUCT TYPE	ELEKTRİKSEL DEĞERLER ELECTRICAL VALUES
KDA 6	230V / 50 Hz / 78W / 0.35A
KDA 8	230V / 50 Hz / 78W / 0.35A
KDA 10	230V / 50 Hz / 78W / 0.35A
KDA 12	230V / 50 Hz / 78W / 0.35A
KDA 15	230V / 50 Hz / 170W / 0.78A
KDA 20	230V / 50 Hz / 170W / 0.78A
KDA 25	230V / 50 Hz / 270W / 1.20A
KDA 30	230V / 50 Hz / 270W / 1.20A
KDA 35	230V / 50 Hz / 270W / 1.20A
KDA 40	230V / 50 Hz / 640W / 3.10A
KDA 50	230V / 50 Hz / 640W / 3.10A

**Buhar İçin Performans Değerleri / Performance Values for Steam**

BUHAR BASINCI VE SICAKLIĞI STEAM PRESSURE AND TEMPERATURE	HAVA GİRİŞ SICAKLIĞI AIR INPUT TEMPERATURE		5°C		10°C		15°C		18°C	
	Ürün Tipi	Üfleme Debisi m <sup>3</sup> / saat	Kapasite Kcal / saat	Hava Çıkış Sic. °C	Kapasite Kcal / saat	Hava Çıkış Sic. °C	Kapasite Kcal / saat	Hava Çıkış Sic. °C	Kapasite Kcal / saat	Hava Çıkış Sic. °C
	Product Type	Air Flow m <sup>3</sup> / hour	Capacity Kcal / hour	Air Output Temp. °C	Capacity Kcal / hour	Air Output Temp. °C	Capacity Kcal / hour	Air Output Temp. °C	Capacity Kcal / hour	Air Output Temp. °C
3 BAR-143°C BUHAR İÇİN FOR 3 BAR-143°C STEAM	KDA 6	1150	6.640	26	6.370	30	6.110	35	6.000	37
	KDA 8	1250	8.790	31	8.470	35	8.160	39	8.000	42
	KDA 10	1150	10.970	41	10.610	44	10.200	48	10.000	51
	KDA 12	1100	12.860	46	12.370	50	11.870	54	12.000	50
	KDA 15	2200	16.480	33	15.890	37	15.290	41	15.000	43
	KDA 20	2100	22.110	44	21.260	48	20.520	51	20.000	54
	KDA 25	2700	27.610	43	26.560	47	25.640	50	25.000	53
	KDA 30	2770	33.080	50	31.950	53	30.810	56	30.000	60
	KDA 35	2700	38.530	57	37.160	60	35.790	63	35.000	65
	KDA 40	4100	44.010	45	42.320	49	40.840	52	40.000	55
KDA 50	4050	55.030	56	53.080	59	51.130	62	50.000	64	
5 BAR-159°C BUHAR İÇİN FOR 5 BAR-159°C STEAM	KDA 6	1150	7.350	29	7.120	33	6.880	37	6.730	40
	KDA 8	1250	9.810	34	9.500	38	9.180	42	8.970	45
	KDA 10	1150	12.250	45	11.890	48	11.480	52	11.250	54
	KDA 12	1100	14.280	52	13.840	55	13.410	58	13.070	61
	KDA 15	2200	18.410	36	17.810	40	17.220	44	16.810	47
	KDA 20	2100	24.620	49	23.880	52	23.040	56	22.570	58
	KDA 25	2700	30.740	48	29.880	51	28.770	55	28.190	57
	KDA 30	2770	36.950	55	35.822	58	34.510	62	33.800	64
	KDA 35	2700	43.000	63	41.630	66	40.260	69	39.400	71
	KDA 40	4100	49.040	50	47.560	53	45.870	57	44.940	59
KDA 50	4050	61.390	62	59.440	65	57.490	68	56.260	70	
6 BAR-164°C BUHAR İÇİN FOR 6 BAR-164°C STEAM	KDA 6	1150	7.580	30	7.350	34	7.120	38	6.960	41
	KDA 8	1250	10.130	35	9.810	39	9.500	43	9.280	46
	KDA 10	1150	12.670	46	12.310	49	11.890	53	11.670	55
	KDA 12	1100	14.780	53	14.280	57	13.840	60	13.570	62
	KDA 15	2200	19.010	37	18.410	41	17.810	45	17.410	48
	KDA 20	2100	25.470	50	24.620	54	23.880	57	23.310	60
	KDA 25	2700	31.790	49	30.870	52	29.880	56	29.240	58
	KDA 30	2770	38.090	57	36.950	59	35.820	63	35.100	65
	KDA 35	2700	44.380	65	43.000	68	41.630	71	40.770	73
	KDA 40	4100	50.730	51	49.040	55	47.560	58	46.630	60
KDA 50	4050	63.340	64	61.680	66	59.440	70	58.210	72	

**Teknik Özellikler / Technical Characteristics**

ÜRÜN TİPİ PRODUCT TYPE	DIŞ ÖLÇÜLERİ / OUTER DIMENSIONS					BUHAR / STEAM		SU / WATER		AĞIRLIK / WEIGHTH	
	A	B	C	D	E	F-Giriş F-Inlet	G-Çıkış G-Outlet	R-Giriş R-Inlet	r-Çıkış r-Outlet	Çelik Boru-Çelik Fin Steel Tube-Steel Fin	Bakır Boru - Alüminyum Fin Copper Tube-Aluminyum Fin
KDA-6	280	910	430	60	150	DN20	1/2"	1/2"	1/2"	38.5	26.3
KDA-8	280	910	430	60	180	DN20	1/2"	1/2"	1/2"	39	27.4
KDA-10	280	910	430	60	180	DN20	1/2"	1/2"	1/2"	44.5	28.1
KDA-12	280	910	430	60	180	DN20	1/2"	1/2"	1/2"	46.5	29
KDA-15	385	1080	485	70	270	DN25	1/2"	3/4"	3/4"	56.5	32.3
KDA-20	385	1080	485	70	270	DN25	1/2"	3/4"	3/4"	69.5	34
KDA-25	545	1220	435	80	280	DN32	3/4"	3/4"	3/4"	97.5	52.5
KDA-30	545	1220	435	80	320	DN32	3/4"	3/4"	3/4"	101	53.4
KDA-35	545	1220	435	80	320	DN32	3/4"	3/4"	3/4"	110	57
KDA-40	645	1430	485	90	340	DN40	1"	1"	1"	131.5	70.9
KDA-50	645	1430	485	90	340	DN40	1"	1"	1"	150.5	74.5

Sıcak Su ve Kızgın Su İçin Performans Değerleri / Performance Values For Heated Water and Hot Water

SU SICAKLIĞI WATER TEMPERATURE	HAVA GİRİŞ SICAKLIĞI AIR INPUT TEMPERATURE		5°C		10°C		15°C		18°C	
	Ürün Tipi	Üfleme Debisi m <sup>3</sup> / saat	Kapasite Kcal / saat	Hava Çıkış Sic. °C	Kapasite Kcal / saat	Hava Çıkış Sic. °C	Kapasite Kcal / saat	Hava Çıkış Sic. °C	Kapasite Kcal / saat	Hava Çıkış Sic. °C
	Product Type	Air Flow m <sup>3</sup> / hour	Capacity Kcal / hour	Air Output Temp. °C	Capacity Kcal / hour	Air Output Temp. °C	Capacity Kcal / hour	Air Output Temp. °C	Capacity Kcal / hour	Air Output Temp. °C
90-70 SICAK SU İÇİN FOR 90-70 HEATED WATER	KTA 6	900	7.800	33	7.220	36	6.650	39	6.310	41
	KTA 8	950	10.100	39	9.360	42	8.620	45	8.180	47
	KTA 10	1450	12.800	33	11.860	37	10.930	40	10.370	46
	KTA 12	1425	14.830	38	13.730	41	12.650	44	12.000	46
	KTA 15	1500	18.640	45	17.260	48	15.900	50	15.090	52
	KTA 20	1400	25.000	63	23.130	64	21.300	66	20.210	67
	KTA 25	3750	31.100	31	28.810	35	26.540	38	25.190	40
	KTA 30	3500	37.140	39	34.440	42	31.760	45	30.170	47
	KTA 35	3500	43.290	45	40.120	47	36.980	50	35.110	52
	KTA 40	4950	49.640	37	46.050	40	42.490	43	40.370	45
KTA 50	4800	62.050	47	57.510	49	53.020	52	50.350	53	

110-80 KIZGIN SU İÇİN FOR 110-80 HOT WATER	KTA 6	900	9.290	38	8.710	42	8.130	45	7.790	47
	KTA 8	950	12.050	46	11.300	49	10.550	52	10.100	52
	KTA 10	1450	15.250	39	14.300	42	13.360	47	12.800	48
	KTA 12	1425	17.680	45	16.570	48	15.470	51	14.820	53
	KTA 15	1500	22.290	53	20.890	56	19.510	58	18.680	60
	KTA 20	1400	30.110	74	28.200	76	26.310	78	25.200	79
	KTA 25	3750	37.020	37	34.710	40	32.420	44	31.050	46
	KTA 30	3500	44.420	46	41.680	49	38.960	52	37.340	54
	KTA 35	3500	51.820	53	48.600	55	45.410	58	43.510	60
	KTA 40	4950	59.370	44	55.730	47	52.120	50	49.960	52
KTA 50	4800	74.360	55	69.730	58	65.170	60	62.450	62	

130-90 KIZGIN SU İÇİN FOR 130-90 HOT WATER	KTA 6	900	10.760	43	10.170	47	9.590	50	9.240	52
	KTA 8	950	13.980	52	13.210	56	12.450	59	12.000	61
	KTA 10	1450	17.680	44	16.720	48	15.770	51	15.200	53
	KTA 12	1425	20.500	51	19.380	55	18.260	58	17.600	60
	KTA 15	1500	25.900	61	24.480	64	23.070	66	22.230	68
	KTA 20	1400	35.170	86	33.210	88	31.280	90	30.130	91
	KTA 25	3750	42.870	42	40.520	45	38.220	49	36.840	51
	KTA 30	3500	51.610	52	48.830	56	46.080	59	44.440	62
	KTA 35	3500	60.270	61	57.000	63	53.750	66	51.820	68
	KTA 40	4950	69.000	50	65.310	53	61.660	56	59.480	58
KTA 50	4800	86.540	63	81.840	66	77.200	69	74.430	70	

Teknik Özellikler / Technical Characteristics

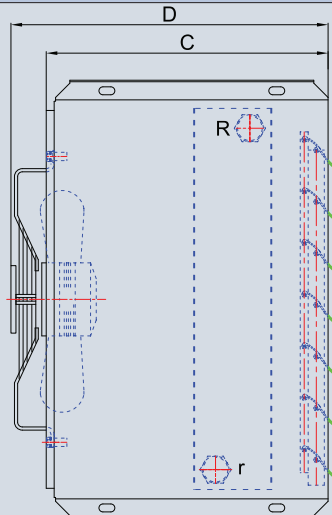
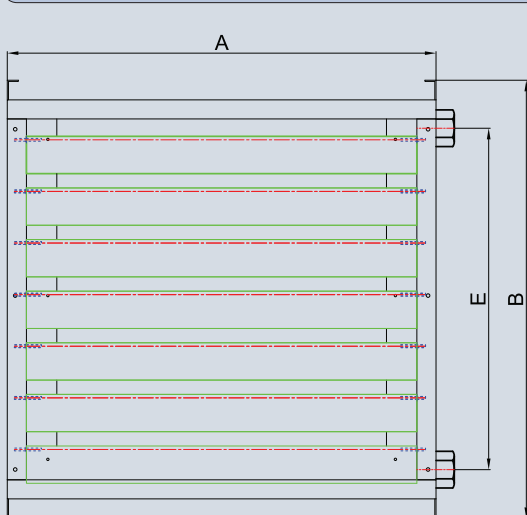

ÜRÜN TİPİ PRODUCT TYPE	ELEKTRİKSEL DEĞERLER ELECTRICAL VALUES
KTA 6	230V / 50 Hz / 86W / 0.62A
KTA 8	230V / 50 Hz / 86W / 0.62A
KTA 10	230V / 50 Hz / 68W / 0.30A
KTA 12	230V / 50 Hz / 68W / 0.30A
KTA 15	230V / 50 Hz / 132W / 0.58A
KTA 20	230V / 50 Hz / 132W / 0.58A
KTA 25	230V / 50 Hz / 160W / 0.73A
KTA 30	230V / 50 Hz / 160W / 0.73A
KTA 35	230V / 50 Hz / 160W / 0.73A
KTA 40	230V / 50 Hz / 245W / 1.10A
KTA 50	230V / 50 Hz / 245W / 1.10A



**Buhar İçin Performans Değerleri / Performance Values for Steam**

BUHAR BASINCI VE SICAKLIĞI STEAM PRESSURE AND TEMPERATURE	HAVA GİRİŞ SICAKLIĞI AIR INPUT TEMPERATURE		5°C		10°C		15°C		18°C	
	Ürün Tipi	Üfleme Debisi m <sup>3</sup> / saat	Kapasite Kcal / saat	Hava Çıkış Sic. °C	Kapasite Kcal / saat	Hava Çıkış Sic. °C	Kapasite Kcal / saat	Hava Çıkış Sic. °C	Kapasite Kcal / saat	Hava Çıkış Sic. °C
	Product Type	Air Flow m <sup>3</sup> / hour	Capacity Kcal / hour	Air Output Temp. °C	Capacity Kcal / hour	Air Output Temp. °C	Capacity Kcal / hour	Air Output Temp. °C	Capacity Kcal / hour	Air Output Temp. °C
3 BAR-143°C BUHAR İÇİN FOR 3 BAR-143°C STEAM	KTA 6	900	6.610	31	6.330	35	6.100	39	6.000	41
	KTA 8	950	8.800	37	8.480	41	8.150	45	8.000	48
	KTA 10	1450	11.040	31	10.590	36	10.260	40	10.000	43
	KTA 12	1425	13.200	37	12.800	41	12.230	45	12.000	47
	KTA 15	1500	14.720	41	14.170	45	13.680	48	15.000	53
	KTA 20	1400	21.250	45	20.430	47	19.650	50	20.000	52
	KTA 25	3750	27.500	34	26.500	38	25.500	42	25.000	45
	KTA 30	3500	32.960	42	31.710	46	30.620	49	30.000	52
	KTA 35	3500	38.530	46	37.040	50	35.740	53	35.000	55
	KTA 40	4950	44.090	38	42.460	42	40.820	46	40.000	48
KTA 50	4800	55.100	48	53.230	51	51.350	54	50.000	58	
5 BAR-159°C BUHAR İÇİN FOR 5 BAR-159°C STEAM	KTA 6	900	7.330	34	7.100	38	6.860	42	6.730	44
	KTA 8	950	9.810	41	9.490	45	9.160	49	8.980	51
	KTA 10	1450	12.270	35	11.870	39	11.480	43	11.260	45
	KTA 12	1425	14.720	41	14.230	45	13.740	49	13.470	51
	KTA 15	1500	16.440	45	15.880	49	15.330	53	15.030	55
	KTA 20	1400	23.660	51	22.870	54	22.090	56	21.710	58
	KTA 25	3750	30.730	37	29.730	41	28.730	45	28.170	47
	KTA 30	3500	36.830	46	35.580	50	34.330	54	33.640	56
	KTA 35	3500	42.950	51	41.650	54	40.160	58	39.340	60
	KTA 40	4950	49.170	42	47.530	46	45.900	50	44.990	52
KTA 50	4800	61.490	53	59.610	56	57.460	60	56.280	62	
6 BAR-164°C BUHAR İÇİN FOR 6 BAR-164°C STEAM	KTA 6	900	7.570	35	7.330	39	7.100	43	6.970	45
	KTA 8	950	10.100	43	9.810	46	9.490	50	9.290	52
	KTA 10	1450	12.670	36	12.270	40	11.870	44	11.650	46
	KTA 12	1425	15.210	42	14.720	46	14.230	50	13.960	52
	KTA 15	1500	16.990	46	16.440	50	15.880	54	15.580	56
	KTA 20	1400	24.440	53	23.660	56	22.870	57	22.380	61
	KTA 25	3750	31.730	38	30.730	42	29.730	46	29.060	49
	KTA 30	3500	37.920	48	36.830	51	35.580	55	34.890	57
	KTA 35	3500	44.440	52	42.950	56	41.460	60	40.830	61
	KTA 40	4950	50.810	43	49.170	47	47.530	51	46.630	53
KTA 50	4800	63.640	54	61.490	58	59.610	61	58.430	63	

**Teknik Özellikler / Technical Characteristics**

ÜRÜN TİPİ PRODUCT TYPE	DIŞ ÖLÇÜLERİ / OUTER DIMENSIONS					BUHAR / STEAM		SU / WATER		AĞIRLIK / WEIGHTH	
	A	B	C	D	E	R-Giriş R-Inlet	r-Çıkış r-Outlet	R-Giriş R-Inlet	r-Çıkış r-Outlet	Çelik Boru-Çelik Fin Steel Tube-Steel Fin	Bakır Boru - Alüminyum Fin Copper Tube-Aluminum Fin
KTA-6	450	450	260	345	325	3/4"	1/2"	1/2"	1/2"	27.2	12.1
KTA-8	450	450	260	345	325	3/4"	1/2"	1/2"	1/2"	29.2	12.3
KTA-10	450	450	260	340	325	3/4"	1/2"	1/2"	1/2"	32.5	12.8
KTA-12	450	450	260	340	325	3/4"	1/2"	1/2"	1/2"	36.5	13
KTA-15	540	550	345	425	360	1"	1/2"	3/4"	3/4"	47.5	18.8
KTA-20	540	550	345	425	360	1"	1/2"	3/4"	3/4"	56.5	21
KTA-25	710	700	375	460	550	1 1/4"	3/4"	3/4"	3/4"	82	30.2
KTA-30	710	700	375	460	550	1 1/4"	3/4"	3/4"	3/4"	85	33.3
KTA-35	710	700	375	460	550	1 1/4"	3/4"	3/4"	3/4"	86	34
KTA-40	810	810	480	565	650	1 1/2"	1"	1"	1"	104.5	50.6
KTA-50	810	810	480	565	650	1 1/2"	1"	1"	1"	112.5	52



Fabrika: Velimeşe Mh. Sultan Sok. No:1 Ergene / Tekirdağ / TÜRKİYE  
Tel: +90 282 676 48 90 Pbx Faks: +90 282 676 48 95  
Web: [www.kontherm.com](http://www.kontherm.com) E- mail: [info@kontherm.com](mailto:info@kontherm.com)

